

## 38mm Slim design, touch screen, and better reliability

## Graphic panel, GP-S044

4.4 inch  
MONO

### ■ Features

- Displays max. 400 characters
- Enables to save max. 500 pages of user screen
- Easy software upgrade at website
  - (1) GP firmware file
  - (2) GP Editor(drawing program)
  - (3) Additional protocol
- Different devices monitoring function
  - : PLC port allows to monitor and control the variables of additionally connected controllers
- Supports multilingual
  - : Supports Korean, Japanese, English, Chinese, Russian, Vietnamese and Portuguese. Additional languages will be available by firmware.
- Supports multi-font
  - : It provides various bitmap and user-selected fonts.
- Various multi-communication port
  - : Both RS232C 2 port and RS232C/RS422 compound port are provided.
- Device monitoring function
  - : It enables to monitor GP devices and connected controller devices by GP without graphic design data.
- Printer and barcode reader connection
  - : It enables to print alarm history connecting a printer and read barcode connecting a barcode reader.
- Compact design
- Various display function
  - : It displays data by various tags.



 Please read "Caution for your safety" in operation manual before using.



※GP-S044 Series is a replacement of GP-2480 Series, discontinued product.

### ■ Manual

Visit our webwite([www.autonics.com](http://www.autonics.com)) to download 'GP Editor user manual' or 'GP, LP user manual for communication', 'GP-S044/S057 user manual'.

- **GP Editor user manual**  
It describes how to write screen data, and is about related usage of GP-S044 HMI function.
- **GP, LP user manual for communication**  
It describes connection for external devices such as PLC.
- **GP-S044/S057 user manual**  
It describes general information on the installation and usage of GP-S044 and system contents.

### ■ Ordering information

Model	Item	Series	Monitor size	Display unit	Color	Power supply	Interface
GP-S044-S1D0	Graphic panel	S series	4.4 inch	STN LCD	MONO (blue, white)	24VDC	RS232C, RS422 (1EA for each)
GP-S044-S1D1							RS232C (2EA)

## ■ Specifications

Model	<b>GP-S044-S1D0</b>	<b>GP-S044-S1D1</b>
Power supply	24VDC	
Allowable voltage range	90 to 110% of power supply	
Power consumption	Max. 3.6W	
Display performance	LCD type	4.4 inch STN Blue Negative
	Resolution	240×80 dots
	Display area	112.8mm×37.6mm
	Color	MONO(blue, white)
	LCD view angle	Top/Bottom/Left/Right 30° in each direction
	Backlight	White LED
	Brightness	Adjustable by software
Graphic drawing performance	Language <sup>※1</sup>	English, Korean, Japanese, Chinese, Russian, Vietnamese, Portuguese
	Text	<ul style="list-style-type: none"> <li>• High resolution display up to 400 letters(6×8 font)</li> <li>• 6×8, 8×8 ASCII characters, high definition numbers</li> <li>• 8×16 ASCII characters, 16×16 regional characters(1-8 times bigger for width, 0.5-5 times bigger for height)</li> </ul>
	Graphic drawing memory	512 KB
	Number of user screen	500 pages
	Touch switch	Width 15×Height 4 = 60
Serial interface	Each port of RS232C, RS422(asynchronous method)	Two ports of RS232C(asynchronous method)
Real-time controller	RTC embedded	
Battery life cycle	Approx. 3 years at 25°C	
Insulated resistance	Min. 100MΩ(at 500VDC megger)	
Ground	3rd grounding(max. 100Ω)	
Noise resistance	± 0.5kV the square wave noise(pulse width: 1μs) by the noise simulator	
Dielectric strength	500VAC(50/60Hz) for 1 min.	
Vibration	Mechanical	0.75mm amplitude at frequency of 10 to 55Hz(for 1 min.) in each of X, Y, Z directions for 1 hour
	Malfunction	0.5mm amplitude at frequency of 10 to 55Hz(for 1 min.) in each of X, Y, Z directions for 10 min.
Shock	Mechanical	300m/s <sup>2</sup> (approx. 30G) in each of X, Y, Z directions for 3 times
	Malfunction	100m/s <sup>2</sup> (approx. 10G) in each of X, Y, Z directions for 3 times
Environ-ment	Ambient temperature	0°C to 50°C, storage: -20°C to 60°C
	Ambient humidity	35 to 85% RH, storage: 35 to 85% RH
Protection ratings	IP65F(for front panel)	
Accessory	Fixing bracket: 4EA, Rubber waterproof ring, Battery(included)	
Approval		
Weight <sup>※2</sup>	Approx. 413g(approx. 284g)	

※1: Language can be customized.

※2: This weight is with packaging and the weight in parentheses is only unit weight.

※Environment resistance is rated at no freezing or condensation.

## ■ Functions

Figure display	Line, rectangle, circle, text, bitmap	
Tags	Numeral display	Displays the designated device as numerical value. (decimal, hexadecimal, octal, binary, real number)
	ASCII display	Displays the designated device value as ASCII character.
	Time display	Displays current time or date.
	Alarm history	Registers alarm history.
	Alarm list	Displays generated (not recovered) alarm.
	Comment display	Displays the designated comment as device status or value.
	Lamp	Displays lamp as device status.
	Part display	Displays the designated parts as device status and value.
	Line graph	Displays several device values with a graph of broken line.
	Trend graph	Displays change of device value for time with a graph of broken line.
	Bar graph	Displays a device value with a bar graph.
	Statistic graph	Displays a ratio of several device values with pie graph.
	Panel meter	Displays a device value as panel meter.
	Touch key	Screen is switched, word/bit device values are set when it touched.
	Numeral input	Configures user input value in device.
ASCII input	Configures user input ASCII code value in device.	
System information function	Monitors/Controls GP operation from PLC.	
Recipe function	Reads/Writes several PLC device collectively.	
Security function	Only acceptable user can observe/operate important data.	
Barcode read function	Connects barcode reader, read barcode.	
Floating alarm function	Warning message is floated when alarm is generated.	
Time operation	Specific bit device is ON/OFF for designated day and time.	
Overlap window	Available to form dynamically overlapping another base screen on the base one.	
Observe status function	Changes PLC device status/value of PLC when trigger is generated.	

(A)  
Photo electric sensor

(B)  
Fiber optic sensor

(C)  
Door/Area sensor

(D)  
Proximity sensor

(E)  
Pressure sensor

(F)  
Rotary encoder

(G)  
Connector/Socket

(H)  
Temp. controller

(I)  
SSR/Power controller

(J)  
Counter

(K)  
Timer

(L)  
Panel meter

(M)  
Tacho/Speed/ Pulse meter

(N)  
Display unit

(O)  
Sensor controller

(P)  
Switching mode power supply

(Q)  
Stepper motor& Driver&Controller

(R)  
Graphic/Logic panel

(S)  
Field network device

(T)  
Software

(U)  
Other

# GP-S044

## ■ Dimensions

(unit : mm)

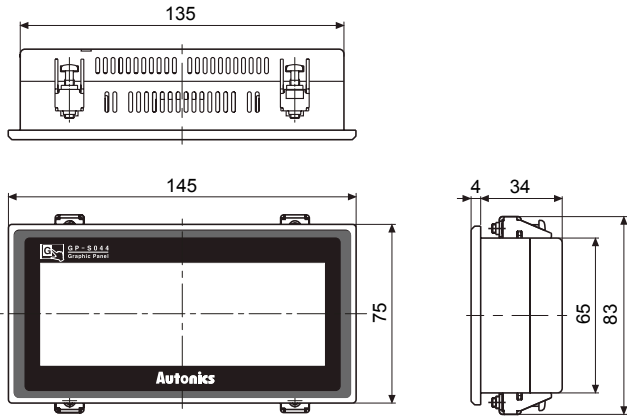

### ● Panel cut-out

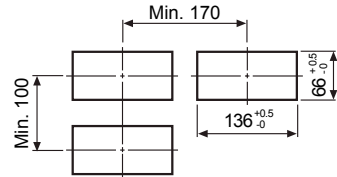

※Panel thickness : Max. 4mm

### ● Fixing bracket

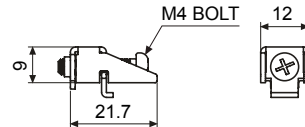

## ■ Part description

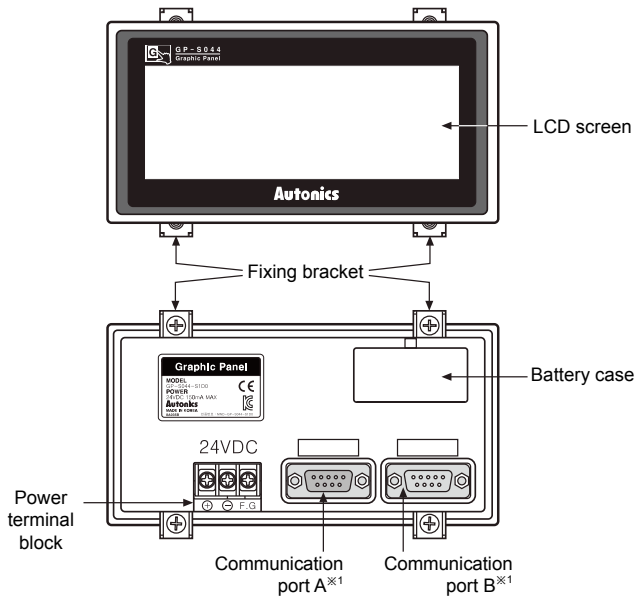

※1: Communication port

Model	Communication port	
	Port A	Port B
GP-S044-S1D0	RS422	RS232C
GP-S044-S1D1	RS232C-A	RS232C-B

※For more information, refer to R-31 page and '■Serial interface' of GP/LP common features.

## ■ Installation

1. Set a rubber waterproof ring after placing the ring's joining part under the GP-S044.
2. Adhere closely between each edge of the GP-S044 and the rings.
3. Set GP-S044 in panel.
4. Set the fix bracket to 4 bracket slots and fix them with bracket's screws.

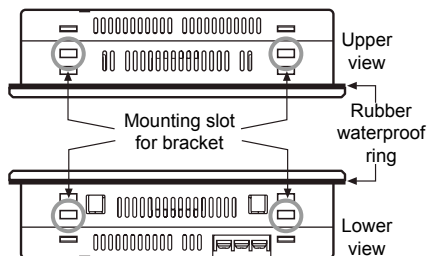

### ● Mounting bracket

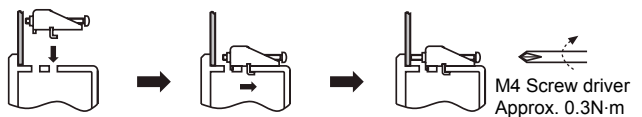

## ■ Sold separately

Transmission cables connectable into external devices such as PLC are sold separately. (refer to the R-32 page for "GP/LP communication cable".)